

<THESE INSTRUCTIONS MUST BE GIVEN TO THE END USER>



B&W Trailer Hitches
 1216 Hawaii Rd / PO Box 186
 Humboldt, KS 66748
 P:800.248.6564
 F:620.869.9031

Call or Email us for
 Installation Support
 hitches@turnoverball.com
 bwtrailerhitches.com

Custom 5th Wheel Hitch Mounting Rail Installation Instructions

MODEL 2503

See Limited Lifetime Warranty at
bwtrailerhitches.com/warranty

2007-2018 Chevrolet & GMC 1500 Trucks

Includes 2019 Chevy LD & GMC Limited 1500 Trucks

MagneRide equipped trucks require additional brackets, call B&W for details.

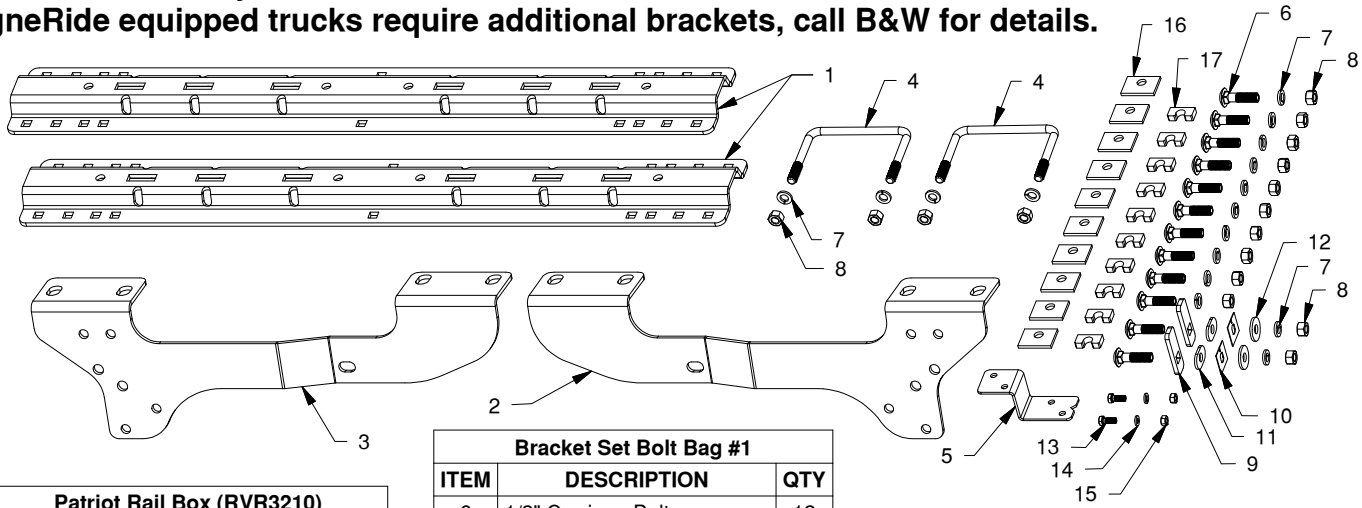

Patriot Rail Box (RVR3210)		
ITEM	DESCRIPTION	QTY
1	Mounting Rail	2

Bracket Set Box (RVR2503)		
ITEM	DESCRIPTION	QTY
2	Side Plate - Passenger	1
3	Side Plate - Driver	1
4	1/2" x 5-1/2" x 4-1/4 U-Bolt	2
5	Relocation Bracket	1

Bracket Set Bolt Bag #1		
ITEM	DESCRIPTION	QTY
6	1/2" Carriage Bolt	12
7	1/2" Split Lockwasher	16
8	1/2" Finish Nut	16
9	1/2" Locking Strap	2
10	1/2" Retainer	2
11	1/2" Frame Bushing	2
12	1/2" Flat Washer	2
13	5/16" Cap Screw	2
14	5/16" Split Lockwasher	2
15	5/16" Finish Nut	2

Bracket Set Bolt Bag #2		
ITEM	DESCRIPTION	QTY
16	Offset Rectangle Washer	10
17	5/16" U-Shaped Spacer	10

⚠️ WARNING

Failure to comply with the safety information in these instructions could result in serious injury or death.

- ⚠️ Read all installation and operating instructions along with all labels before using this product.
- ⚠️ Adding components to the chassis of any vehicle can be hazardous. There is potential for damage to vehicle, injury from tool usage and many other hazards. This installation must be completed by someone who is aware of the hazards involved. This person must be knowledgeable of proper safety procedures for a vehicle installation of this nature, and for usage of the equipment required to perform the installation.
- ⚠️ Without proper knowledge, towing can be a dangerous activity. Understand all the risks involved with towing before proceeding. For information on towing safety, see **"The Trailer Handbook: A guide to Understanding Trailer and Towing Safety"** from the *National Association of Trailer Manufacturers*, www.NATM.com and your trailer manufacturer's owner's manual.
- ⚠️ Regularly check that all bolted connections are at the correct torque specification. A visual inspection should be performed before each time you tow.
- ⚠️ Additional caution must be used when towing a wedge car trailer. Towing stability greatly depends on keeping the center of gravity as low as possible. Load heavy cars over the axles. Never tow with a single car on the front of the trailer. When towing a wedge car trailer, never exceed speeds that are reasonable for the roadway conditions (e.g. turns, going around a curve, etc.). Failure to account for proper trailer center of gravity and speeds that are reasonable for the roadway conditions may cause damage to the truck, trailer, towing components, and loss of attachment between the truck and trailer.
- ⚠️ Do not modify this product in any manner. Doing so could alter its integrity and lead to a loss of attachment between the trailer and the tow vehicle.
- ⚠️ Do not exceed tow or tongue rating of coupler, tow or tongue rating of hitch, or tow or weight ratings of truck or trailer. See vehicle and trailer manufacturer information for ratings. Exceeding these ratings may cause damage to towing components or loss of attachment between the trailer and truck.

PREPARING TO INSTALL

NOTICE: If truck is equipped with a removable bed liner or mat, it should be removed or it must be cut to allow the mounting rails to connect directly with the bed. It is acceptable to install the mounting rails over a spray in bed liner.

NOTE: Remove all parts from the packaging and familiarize yourself with all the parts and tools required. Use the parts list on the front page to verify that all parts and hardware are present.

Installation of the mounting rails requires several common tools and a few specialized tools. Below is a listing of equipment used during a typical installation.

- Impact wrench or ratchet with 1/2" & 3/4" sockets
- 1/2" & 3/4" box end wrench
- A drill and 1/8" & 9/16" Drill bits
- Patriot 5th wheel or Slider Base
- Hammer
- Flashlight
- Tape Measure
- Eye Protection
- Ear Protection
- Torque Wrench
- Center Punch Tool

1. **Install relocation bracket.** A small "L" shaped relocation bracket is provided to change the location of a frame mounted bracket. This bracket holds the brake lines close to the inside of the driver side frame. Adding the relocation bracket will move the brake lines so there is room to install U-bolts. Disconnect the truck brake bracket by removing the two bolts on top of the frame. Attach the relocation bracket to the top of the frame using the same holes and hardware. Re-attach the truck brake bracket to the holes in the relocation bracket with two 5/16" cap screws, lock washers, and nuts, see Figure A1.

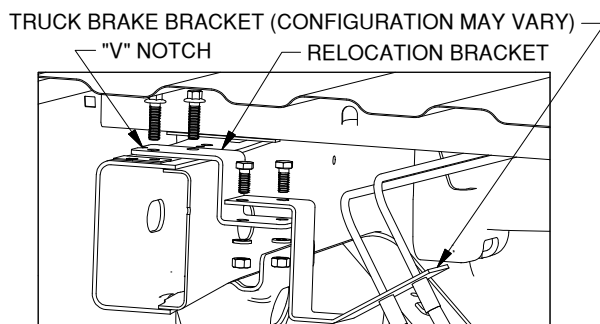
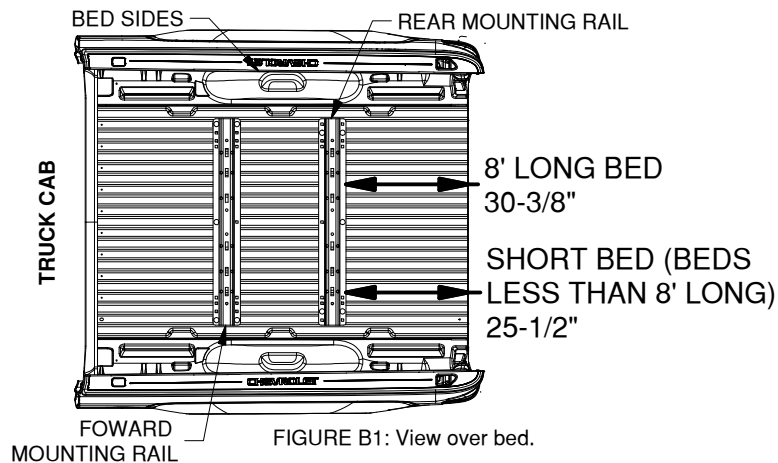

Figure A1: View looking at cut-away of frame over the axle.

DRILL REAR MOUNTING HOLES

1. **Layout the rear mounting rail.** Place a mounting rail onto the bed of the truck. Hook a tape measure over the rear edge of the bed (not on any part of the tailgate), measure the location for the mounting rail as shown in Figure B1. Next, center the mounting rail in the bed by measuring the distance on either side from the edge of the rail to the sides of the bed. The rail will be centered when both measurements on either side of the rail are the same.



IMPORTANT: If your truck has a spray-in bed liner you will need to take this into account when you are measuring, and add the thickness of the applied liner that has been sprayed over the end of the bed.

IMPORTANT: The mounting rail is designed to install only at the described location. Failure to place the mounting rail precisely may result in added difficulty during installation and/or property damage.

2. **Mark hole locations.** While carefully ensuring the mounting rail does not move, use a center punch tool to mark the 5 drill locations on the rear rail. See Figure B2 for hole marking locations for this installation (forward rails will install on a later step). Once all 5 rear rail locations are clearly marked, move the bed rail out of the way and drill each location with an 1/8" drill.

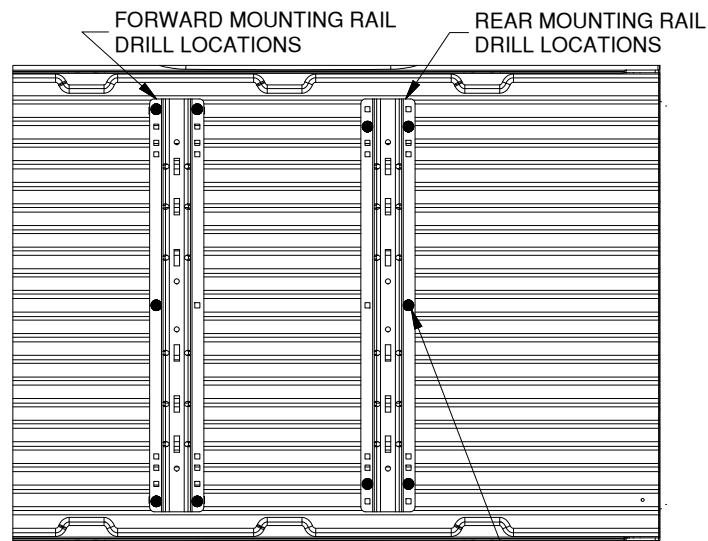
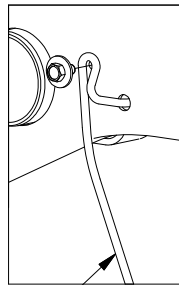

Figure B2: Detail view over bed, showing drill locations for the forward and rear bed rails.

⚠ The fuel tank of the truck may be directly below the area of the bed which needs to be drilled. Always carefully examine the area under the truck where drilling will occur before drilling. Make certain that the tank, or other equipment, is not damaged during drilling. Damage to the tank may result in property damage, serious injury or death.

INSTALL FRAME CARRIAGE BOLTS

NOTICE: On some short bed trucks, a wire cable bracket may be located where the driver side plate will be installed. It may be necessary to temporarily remove the bracket by removing the bolt attaching it to the frame. Replace the bracket after the side plates are securely installed, see Figure C1.



WIRE BRACKET — Figure C1

- 1. Install carriage bolts.** Each side plate is attached to the frame with the help of a locking strap. To begin, locate mounting hole in the frame, attach the carriage bolts to the locking straps by passing the bolts through the straps. Insert the locking straps through the holes in the frame until they are completely inside the frame and only the carriage bolt is passing through the holes, see Figure C2.

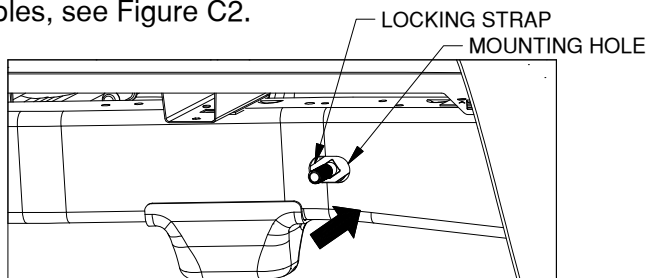

Figure C2: View looking into driver side wheel well.

- 2. Install frame spacers.** Install a frame spacer into each hole over the carriage bolt. To prevent the carriage bolts from falling into the frame. Thread a 1/2" retainer onto each bolt until it is snug against the frame, see Figure C3. Repeat steps 1 & 2 on the other side of the truck.

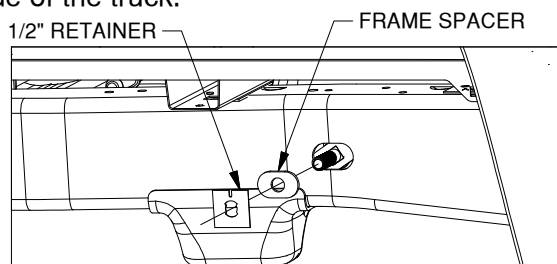

Figure C3: View looking into driver side wheel well.

- 3. Check hole locations.** Using the side plates, align each bracket to the side of the frame where the side plates will be installed, see Figure C4. Check that the 1/8" holes are centered within the slots in the side plates, see Figure C5. If the 1/8" drilled holes are not centered re-drill the 1/8" holes until the side plates and the drilled holes are aligned.

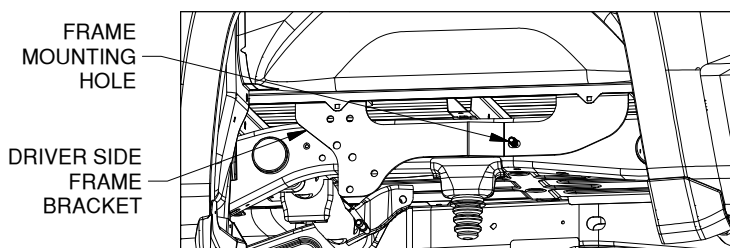

Figure C4: View looking into driver side wheel well.

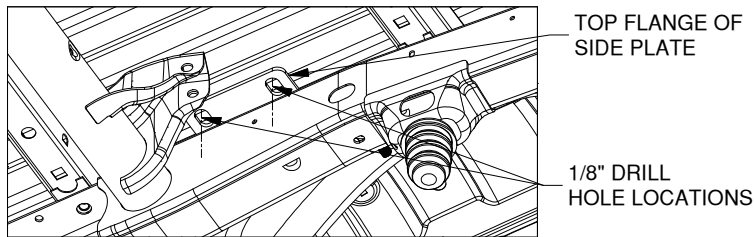

Figure C5: View under bed looking up at drilled area and side plate.

- 4. Enlarge the holes.** Use the 1/8" holes as pilots, drill out each hole with a 9/16" bit.

INSTALL SIDE PLATES

- 1. Place side plates over carriage bolts.** Each side plate (driver and passenger side) will install over the carriage bolts previously placed into the frame. Attach each plate (driver side shown below) with 1/2" washers, 1/2" lock washers and 1/2" finish nuts, see Figure D1. Do not fully tighten at this time.

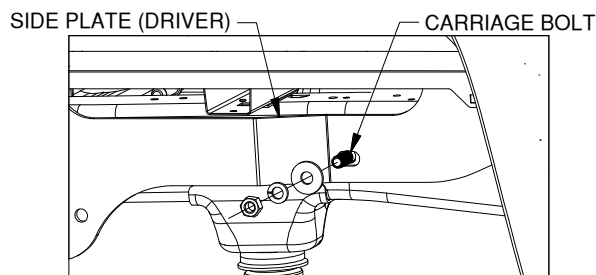

Figure D1: View looking into driver side wheel well.

- 2. Install the U-bolt.** The frame geometry differs between the long bed and short bed versions of the truck. Use Figures D2 & D3 to determine which set of holes you will need to install the U-bolt through depending on the configuration of the truck. Locate a 1/2" x 5 1/2" x 4 1/4" U-bolt, two 1/2" split lockwashers, and two 1/2" finish nuts. Pass the U-bolt up past the frame and under any wiring or brake lines. Turn the U-bolt into the correct mounting holes in the side plate and secure as shown in Figure D4.

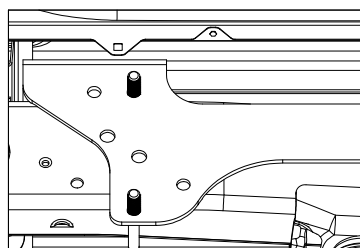

Figure D2: Long Bed U-bolt location.

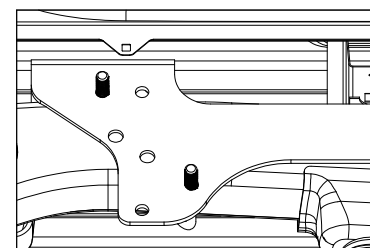

Figure D3: Short Bed U-bolt location.

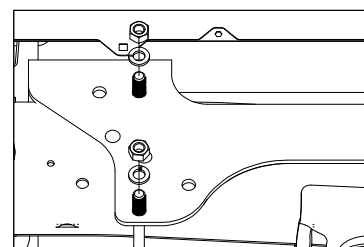

Figure D4: View looking into driver side wheel well.

INSTALL MOUNTING RAILS

NOTICE: Due to the corrugation in the truck bed, U-shaped spacers are provided to function as space fillers between the mounting rails and the kit attachment hardware. Always place a U-shaped spacer in the gap either above the bed (between the mounting rail and the bed) or below the bed (between the bed and the side plates). Failure to use U-shaped spacers will result in property damage when hardware is tightened.

- 1. Install the rear mounting rail.** Re-position the rear mounting rail over the drilled 9/16" holes in the bed. Install a 1/2" carriage bolt through the mounting rail into each of the five drilled holes, as shown in Figure E1. Under the bed install an offset square washer, 1/2" lock washers and 1/2" finish nuts on each of the carriage bolts, see Figure E2. Place the U-shaped spacers. Hand tighten each nut.

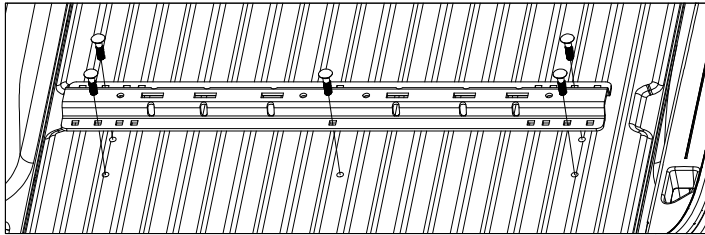

Figure E1: View looking into truck bed from rear of truck.

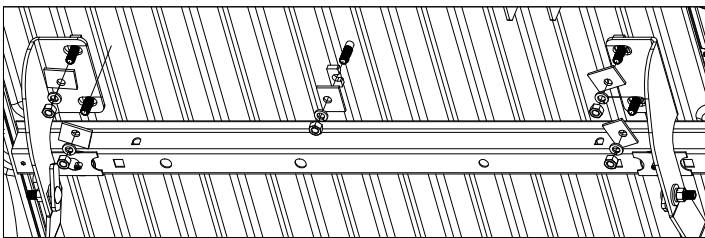

Figure E2: View under bed looking up toward cab. (Frame not shown)

- 2. Position the forward mounting rail.** For this step the base which will be used in the mounting rails is required. Place a mounting rail into the truck bed in front of the rear mounting rail. Place the base over the rail attachment points and carefully lower it until the pin tabs pass through the attachment points on the rear mounting rail. Attach the forward mounting rail to the forward mounting points on the base. The base should rest flat against the top of the rails, see Figure E3. With the base still attached ensure that the forward rail is centered in the truck bed.

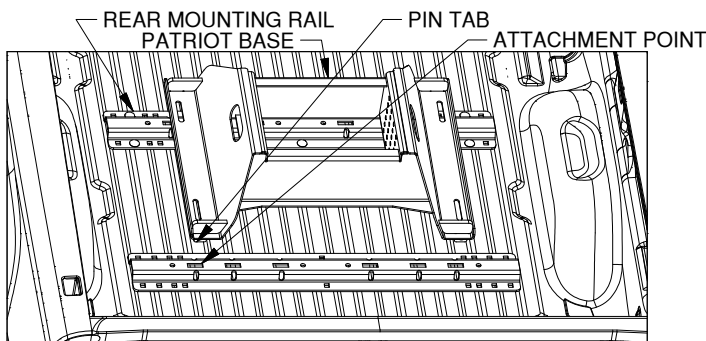

Figure E3: View into truck bed looking back at tailgate.

- 3. IMPORTANT:** Before drilling forward mounting holes pull the RV base towards the rear of the truck and push the forward rail towards the cab of the truck to correctly space the mounting rails, see Figure E4.

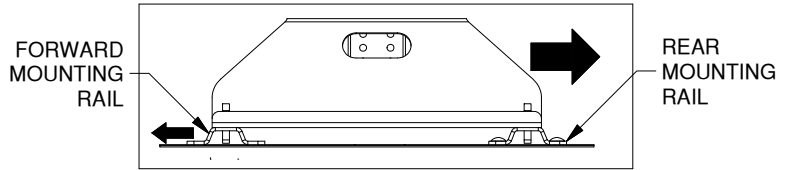

Figure E4: Side view of RV base and mounting rails.

- 4. Drill forward mounting holes.** Using the same methods as used for the rear mounting rail, mark, drill, check, and enlarge the holes for the forward mounting rail. Start at "DRILL REAR MOUNTING HOLES" section, Step 2, on a previous page. Notice that the hole locations are slightly different than the rear rail, see Figure B2 (on the second page).
- 5. Install forward mounting rail.** Refer to the "INSTALL MOUNTING RAILS" section, Step 1, and install the forward mounting rail. Notice that the U-shaped spacer placement is different. See Figures E5 and E6.

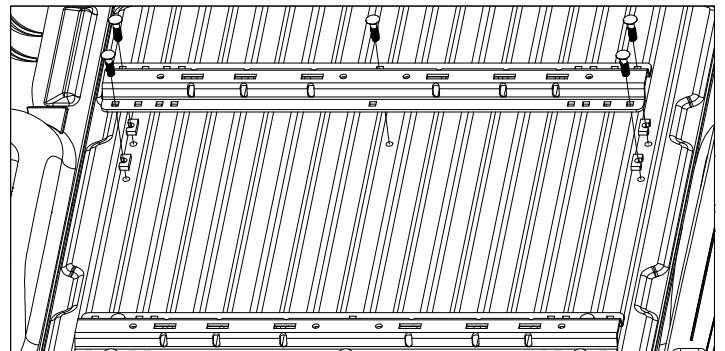

Figure E5: View looking into truck bed from rear of truck.

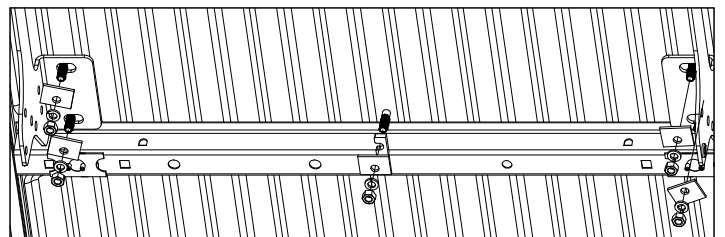

Figure E6: View under bed looking up toward cab. (Frame not shown)

- 6. Tighten hardware.** Using a torque wrench, first torque all the 1/2" nuts in the mounting rails to 80 ft-lbs. Second, torque the 1/2" nuts in the side plates to 80 ft-lbs. Third, tighten the U-Bolts. Tighten the U-bolts slowly; alternating between the top and bottom legs of the U-bolt until equally tightened to a maximum of 40 ft. lbs. This torque may not be obtained without bending the sideplate some. This is normal and will not hinder the function of the hitch.